



SMX 250

	25,20 m		23,20 m		7,90 m (250 kg) 11,60 m (80 kg)
	250 kg		1,40x0,70x1,10 m		90°+90°
	360°		KUBOTA 10,9kW/ 3200 rpm		2,2 kW/ 230 V 50 hz/ 1500 rpm
	1,2 km/h 2,4 km/h		14°/25%		2600 kg

SMX250

I R O N I K A

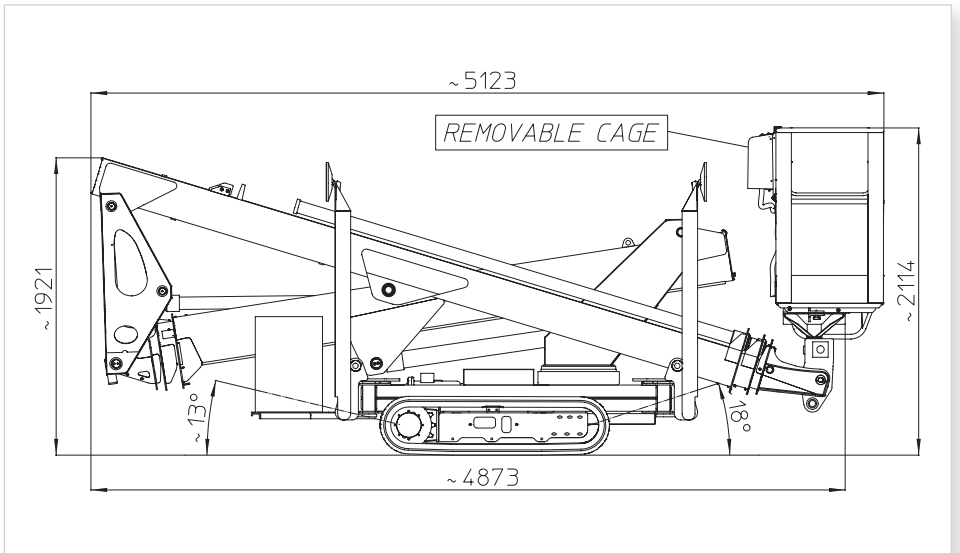
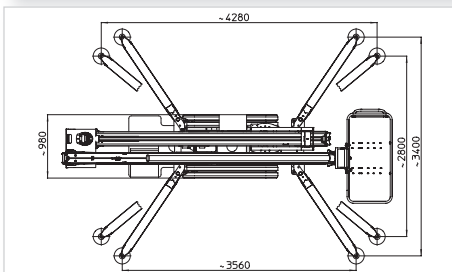
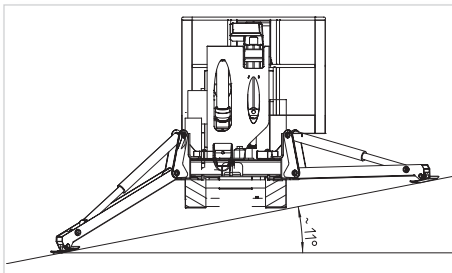
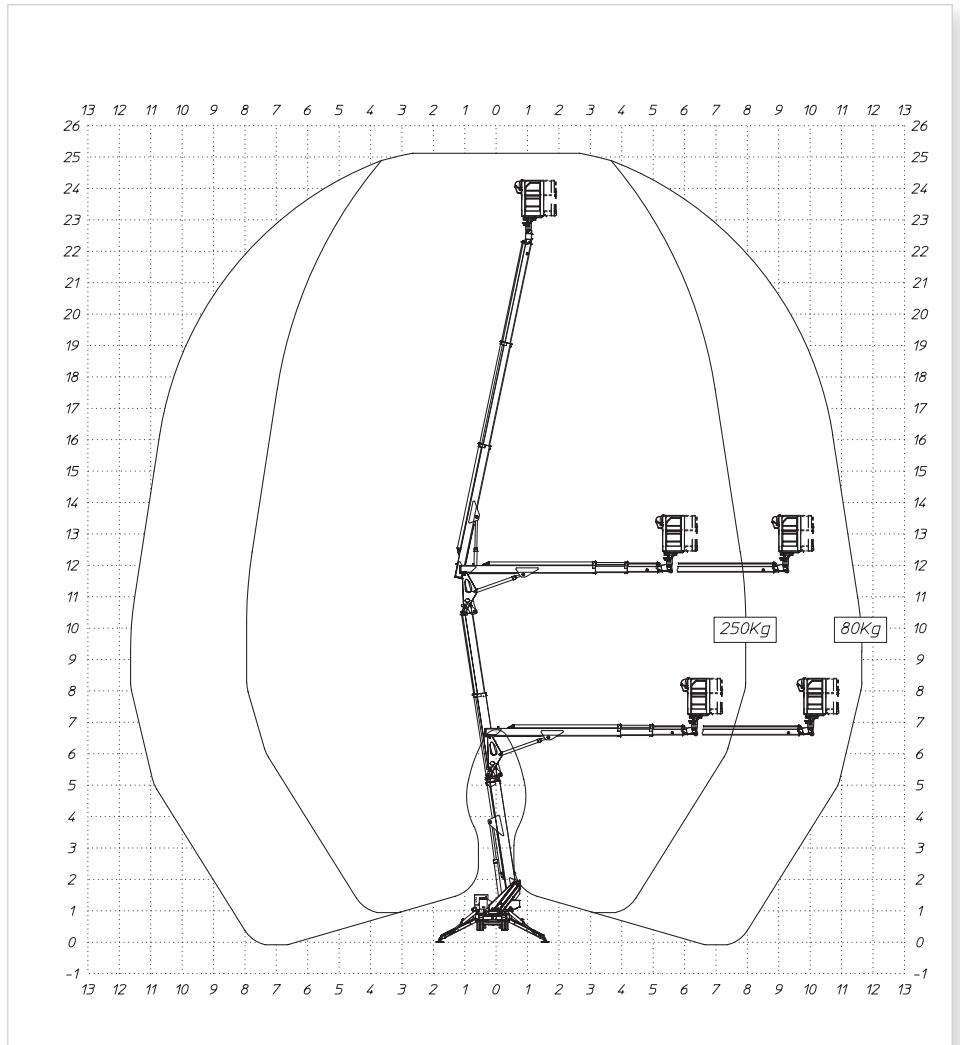
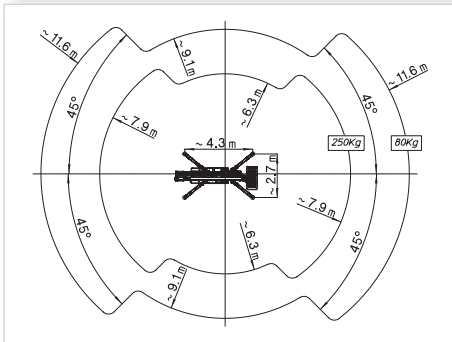
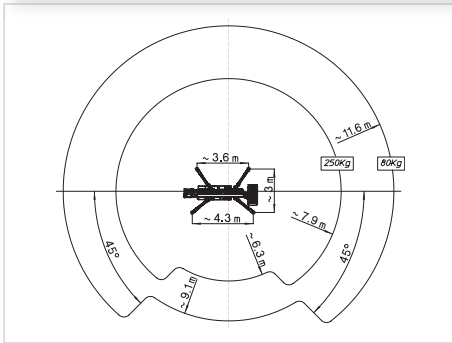
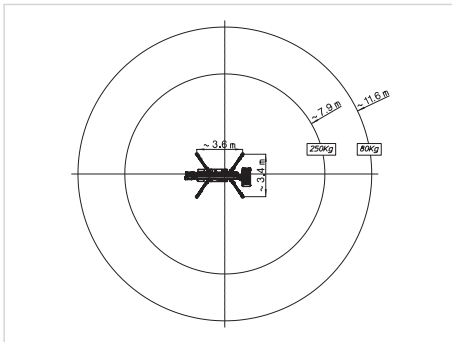

MULTITEL PAGLIERO S.P.A.

Strada Statale, 114
12030 MANTA (CN) - ITALY
Tel. +39 0175 255211- Fax +39 0175 255255
info@pagliero.com

Filiali

Corso Piemonte, 54
10099 S.MAURO T.SE (TO) - ITALY
Tel. +39 011 2236792 - Fax +39 011 2236761

Via dell'Offelera, 106
20861 BRUGHERIO (MB) - ITALY
Tel. +39 039 883393/4 - Fax +39 039 2872140

MULTITEL INTERNATIONAL SAS

87, rue du Morellon
38070 ST. QUENTIN FALLAVIER - FRANCE
Tel. +33 (0)4 74 94 63 19 - Fax +33 (0)4 74 94 46 97
info@multitelinternational.com

MULTITEL EXPORT SALES GmbH

Carl-Zeiss-Straße, 34
52477 ALSDORF - DEUTSCHLAND
Tel. +49 (0) 2404 675 580 - Fax +49 (0) 2404 675 58 29
export@pagliero.com

MULTITEL UK Ltd

c/o Simmons Gainsford
7/10 Chandos Street, Cavendish Square - London W1G 9DQ
info.uk@pagliero.com

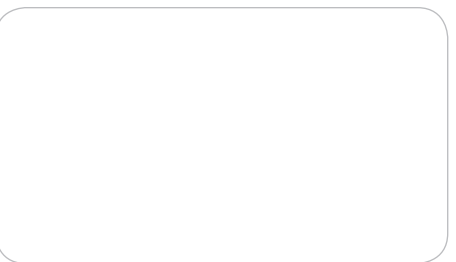

www.multitelgroup.com